

Tower Mounted Booster

Product Description

Kavveri's TMB system is a cost efficient solution for areas with low traffic capacity requirements, such as highway coverage, rural areas, intercity connections, etc.

The TMB system is to be installed near to the antenna, ensuring best possible uplink sensitivity of the system and hereby increase the usable cell size. The amplifiers in the down link path will equally increase the EIRP of the antenna and thereby complement the improved up-link, resulting in a balanced coverage equivalent to a macro cell.

Block Diagram

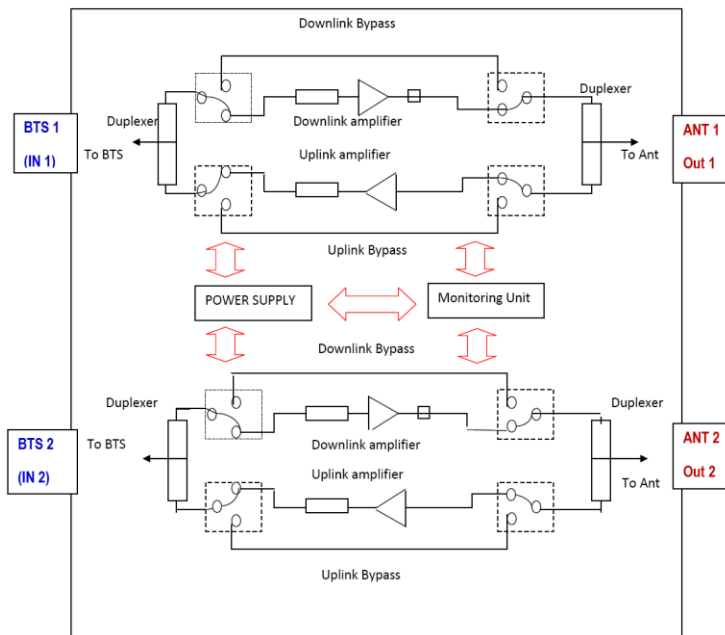

Tower Mounted Booster

Technical Specifications

Model No	119 000 46
Frequency Range (Uplink):	890 – 915 MHz
Frequency Range (Downlink)	935 – 960 MHz
Output Power	46 dBm / Ch
No of Channels	2
UL Gain Adjustment	0 -12 dB (1 dB Step)
DL Gain Adjustment	0 -25 dB (1 dB Step)
Pass Band Ripple	< 2 dB
Spurious & IMD	≤-36 dBm (9 KHz - 1GHz) ≤-30 dBm (1 GHz - 12.75 GHz)
Noise figure uplink	≤ 3 dB
Downlink input power range	25 - 40 dBm
VSWR	≤ 1.4
Bypass range	≤ 3 dB
System Group delay	≤ 1.5 μ sec
Impedence	50 Ohms
Operating voltage	230 VAC or - 48 VDC
Power consumption	< 350 Watts
Power up warming time	75 sec
Weight	45 Kgs
Dimension (LxWxH)	630 x 430x 220mm
Connectors	7/16 DIN (F)
Colour	Siemens Grey
Cooling	Conduction Mode
Mounting	Wall / Pole Mounting
Cabinet	IP 65 Compliant
Operating temperature	- 20° C to + 70° C

Product Photo

